

53000 EW10



53005 EW20



53005-01	EW20-01	70x22x8	Ultra-thin
53005-02	EW20-02	70x22x12	Standard

53010 EW30



53010-01	EW30-01	110x22x8	Ultra-thin
53010-02	EW30-02	90x22x12	Standard

53015

EW40



53020

EW50



53025

EW60



53030

EW70



53035

EW80



53040

EW90



53045

EW100



53050 EWA



53035	EW80	1PCS
53025	EW60	3PCS
53000	EW10	2PCS
53005-02	EW20-2	2PCS
53010-02	EW30-2	2PCS
53020	EW50	6PCS

53055 EWB



53045	EW100	6PCS
53000	EW10	2PCS
53005-02	EW20-2	2PCS
53010-02	EW30-2	2PCS
53020	EW50	6PCS

53060

WPA

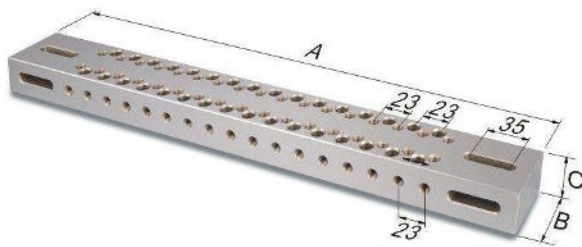

		A	B	C	
53060-01	WPA-370	370	50	30	4.00kg
53060-02	WPA-450	450	50	30	5.00kg
53060-03	WPA-520	520	50	35	7.00kg
53060-04	WPA-550	550	60	35	9.00kg
53060-05	WPA-650	650	60	35	10.5kg

53065

WPB

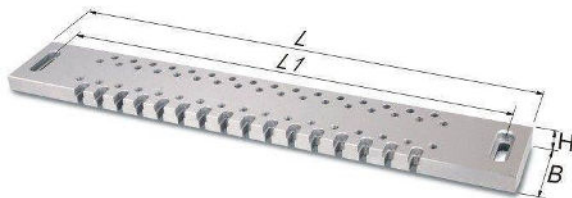

		L	L1	B	H	
53065-01	WPB-370	370	320	75	20	4.00kg
53065-02	WPB-480	480	430	75	20	5.20kg
53065-03	WPB-520	520	480	75	20	6.00kg
53065-04	WPB-550	550	500	90	22	8.20kg
53065-05	WPB-600	600	550	90	22	9.00kg
53065-06	WPB-650	650	600	90	22	10.0kg
53065-07	WPB-750	750	700	90	22	11.3kg

53068 WPT100



4.5kg

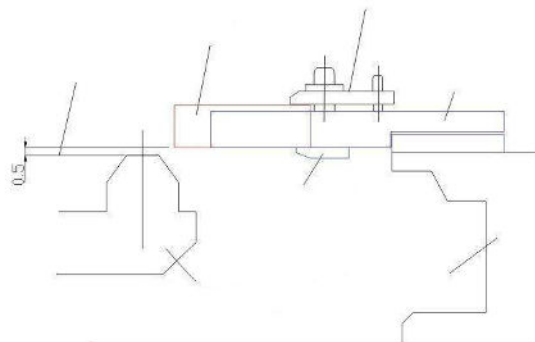
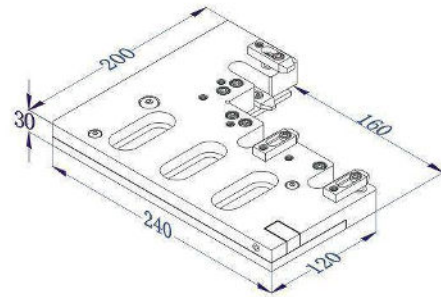
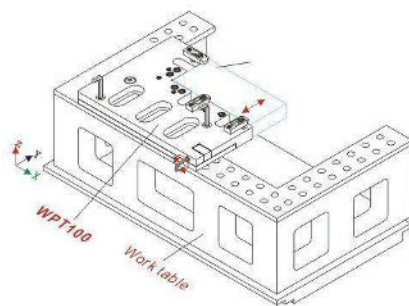
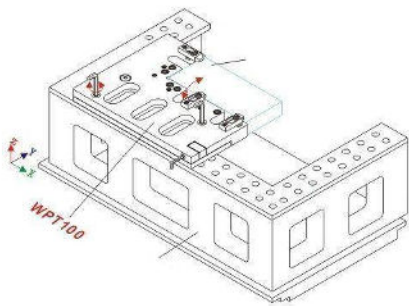
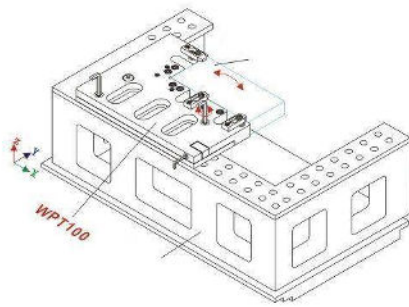

53070 WPT200

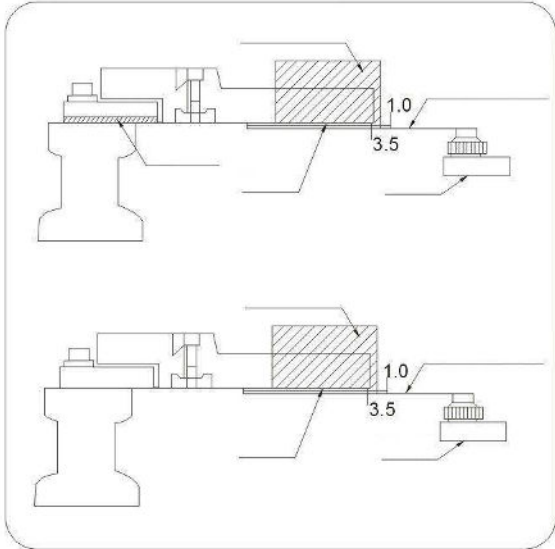
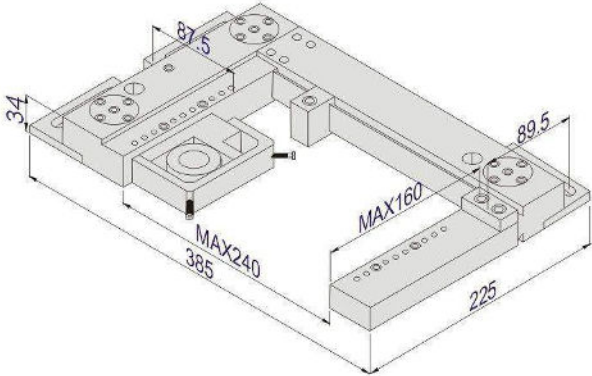
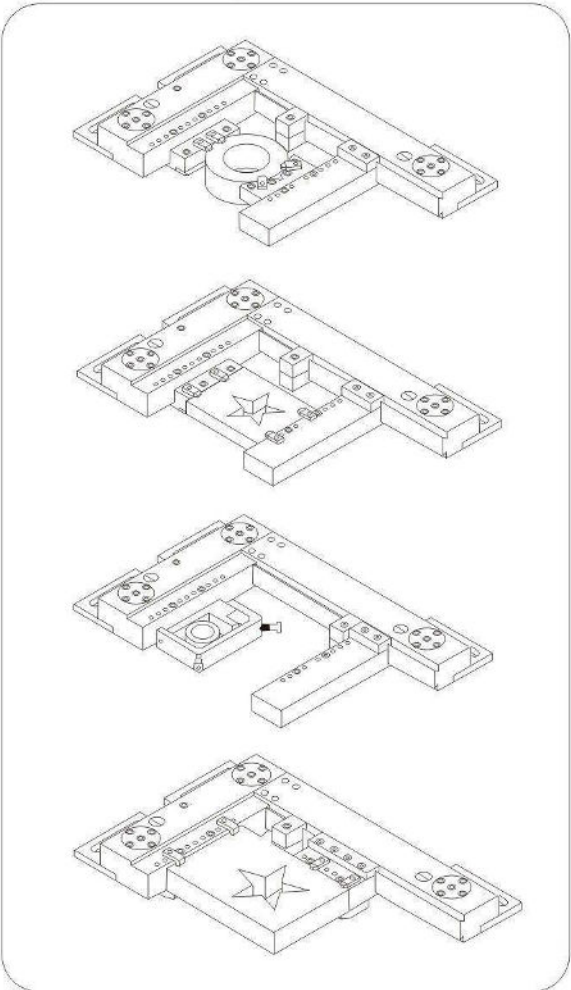
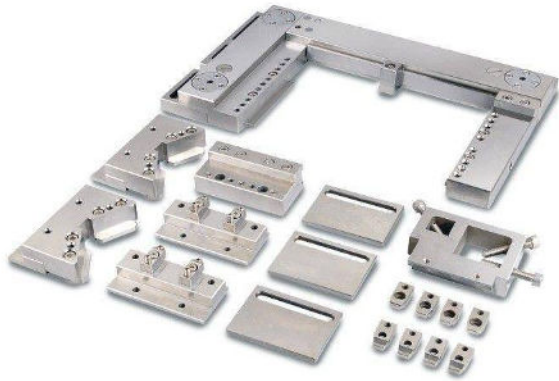

53100 WST001



1.8kg

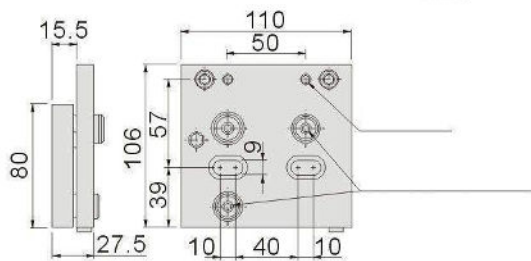

53105 WST080

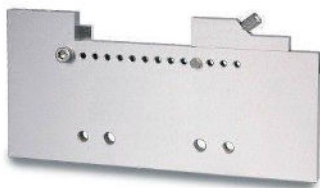

0.8kg

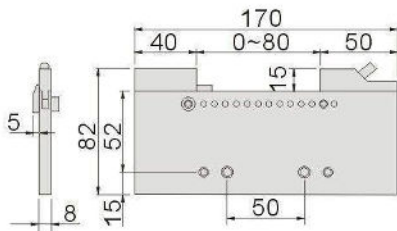

53110 WST100

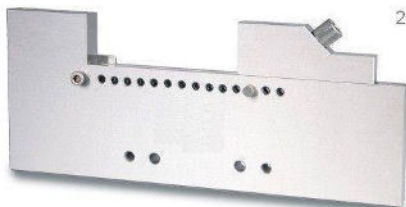

2.0kg

