

52700 VJ10

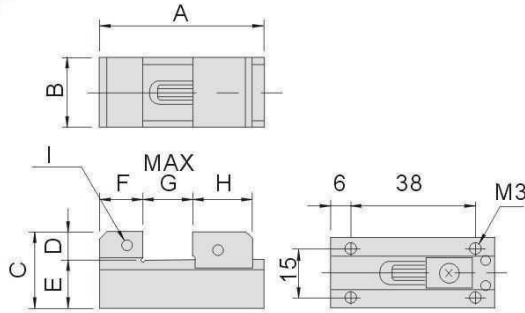

Spec	Model	VJ10
A		50
B		21
C		23.5
D		8.5
E		15
F		13
G		15
H		18
I		M3
N.W.		0.15kg

52715 VLW10

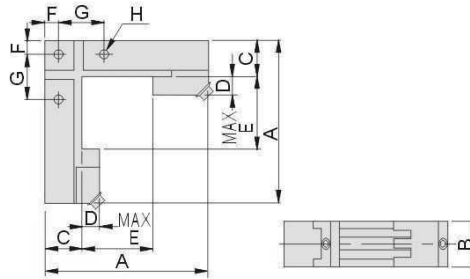

Spec	Model	VLW10
A		90
B		25
C		20
D		10
E		40
F		7.5
G		25
H		M5
N.W.		0.5kg

52720 VL 10

52720-01 VL10-1
52720-02 VL10-2

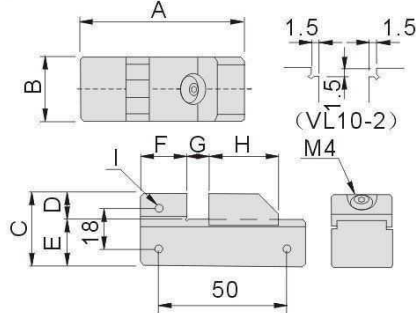

Spec	Model	VL10-1	VL10-2
A		65	65
B		25	25
C		32	32
D		12	12
E		20	20
F		20	20
G		20	20
H		25	25
I		M4	M4
N.W.		0.25kg	0.25kg

52725 VL20/30

52725-20 VL20
52725-30 VL30

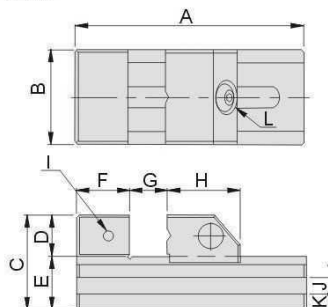

Spec	Model	VL20	VL30
A		140	180
B		50	72
C		53	62
D		25	30
E		28	32
F		25	35
G		0~75	0~100
H		40	45
I		M6	M6
J(WXD)		6x5	8x7
K		8.5	9
N.W.		1.5kg	3.0kg

52730 VSU10

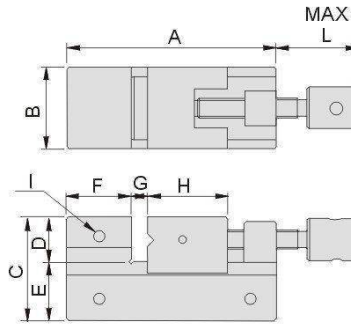
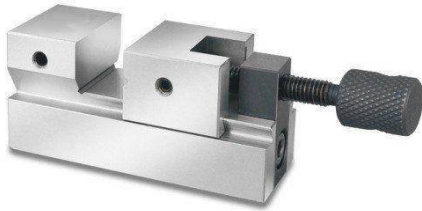

Spec	Model	VSU10
A		70
B		25
C		32
D		14
E		18
F		20
G		0~25
H		25
I		M4
L		43
N.W.		0.5kg

52735 VSU15

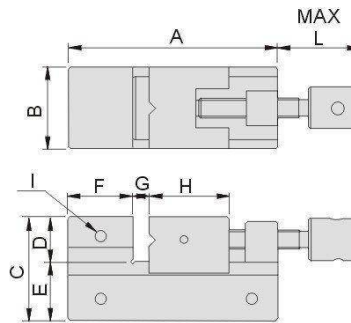
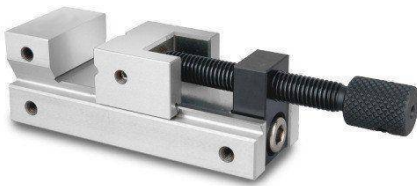

Spec	Model	VSU15
A		100
B		36
C		35
D		16.5
E		18.5
F		20
G		0~50
H		30
I		M5
L		76.5
N.W.		1.0kg

52740 VSU30

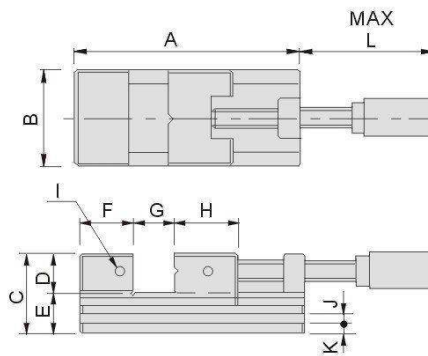
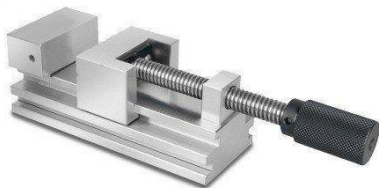

Spec	Model	VSU30
A		180
B		70
C		69
D		30
E		39
F		35
G		0~100
H		45
I		M6
J(WXD)		8x8
K		8
L		165.5
N.W.		4.2kg

52745 DSU80

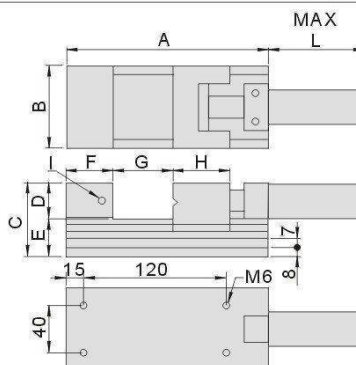
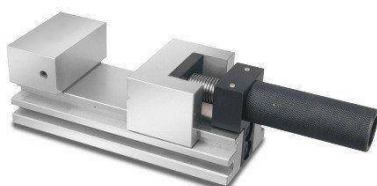

Spec	Model	DSU80
A		170
B		70
C		62
D		30
E		32
F		40
G		0~80
H		45
I		M6
L		82
N.W.		4.2kg

52750 DSU20/30

52750-20 DSU20
52750-30 DSU30

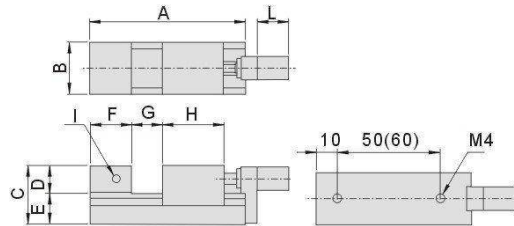
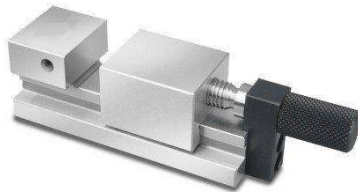

Spec	Model	DSU20	DSU30
A		75	95
B		25	30
C		28	35
D		13	15
E		15	20
F		20	20
G		0~20	0~30
H		30	40
I		M4	M4
L		20	20
N.W.		0.27kg	0.65kg

52755 DSU40/50

52755-40 DSU40
52755-50 DSU50

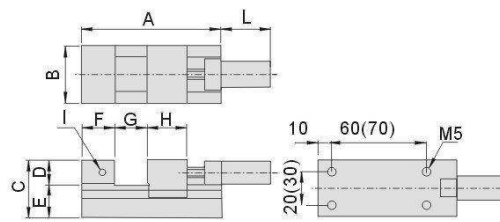
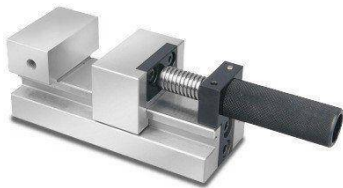

Spec	Model	DSU40	DSU50
A		95	110
B		35	45
C		35	45
D		15	20
E		20	25
F		20	25
G		0~40	0~50
H		24	24
I		M5	M5
L		45	55
N.W.		0.9kg	1.6kg

52760 PMV30

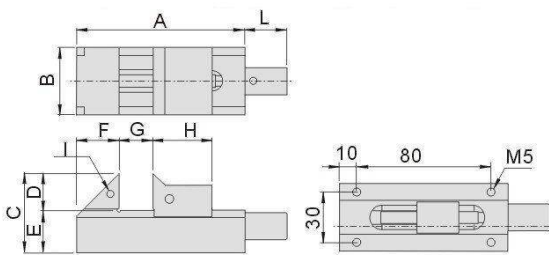
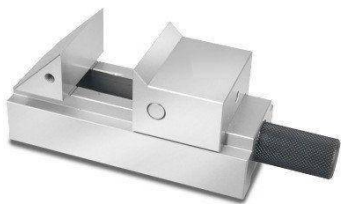

Spec	Model	PMV30
A		100
B		40
C		47
D		22
E		25
F		25
G		30
H		35
I		M4
L		31.5
N.W.		0.90kg

52765 PMV30F

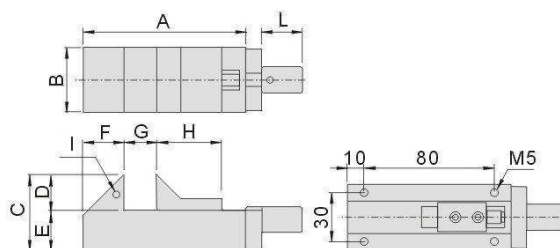
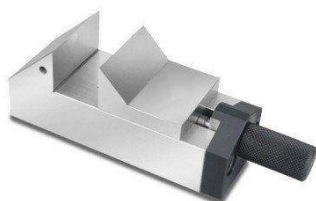

Spec	Model	PMV30F
A		100
B		40
C		47
D		22
E		25
F		25
G		30
H		40
I		M4
L		30
N.W.		0.93kg

52770 VE30/50

52770-30 VE30
52770-50 VE50

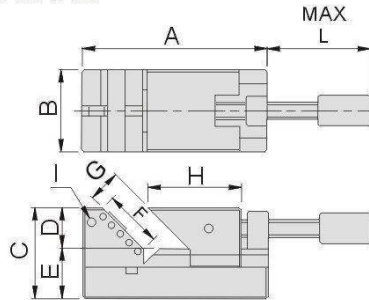

Spec	Model	VE30	VE50
A		62	90
B		30	50
C		37	44
D		15	20
E		22	24
F		21	33.9
G		0~11	26
H		37.5	45.4
I		M4	M4
L		33.5	65
N.W.		0.5kg	0.7kg

52775 VR40

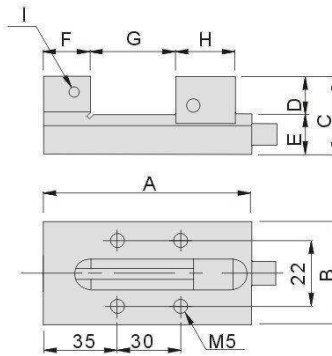
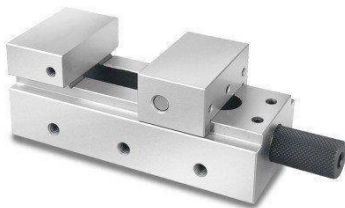

Spec	Model	VR40
A		100
B		40
C		40
D		15
E		25
F		25
G		0~40
H		25
I		M4
N.W.		1.0kg

52780 VK35

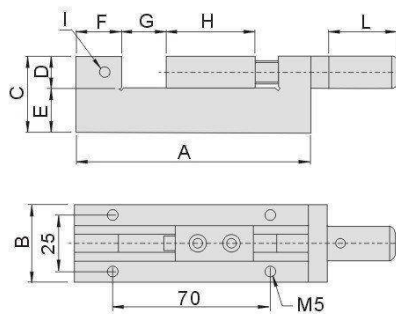

Spec	Model	VK35
A		105
B		35
C		35
D		15
E		20
F		20
G		0~30
H		40
I		M4
L		30
N.W.		1.1kg

52790 VSP50

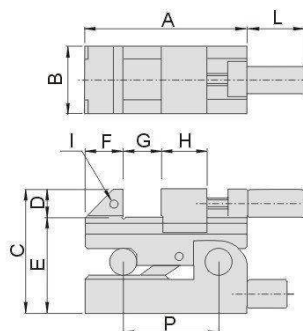

Spec	Model	VSP50
A		85
B		35
C		65
D		15
E		50
F		20
G		0~30
H		24
I		M4
L		37
P		50
N.W.		1.0kg